

PRO-C®

Residential and Light Commercial
Irrigation Controller



Sales - Service - Installation

Call Our Team Now On:

09-215-7310

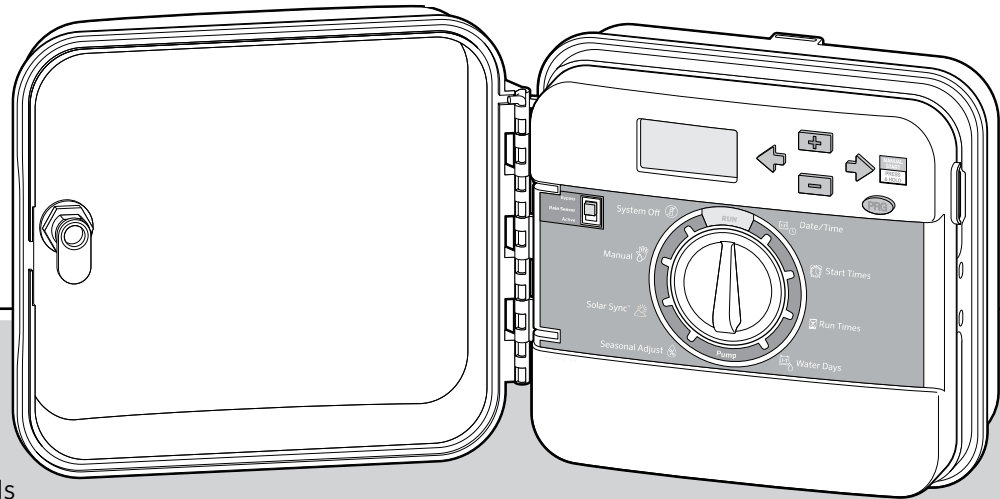

PC Series
Modular Controller
Indoor/Outdoor Models

Owner's Manual and
Installation Instructions

Hunter®

Table of Contents

Introduction and Installation

- 3 Specifications
- 4 Pro-C Components
- 8 Mounting the Controller to a Wall
- 9 Connecting AC Power
- 10 Installing Station Modules
- 11 Connecting Station Wires
- 12 Connecting the Battery
- 13 Connecting a Master Valve
- 14 Connecting a Pump Start Relay
- 15 Connecting a Hunter “Clik” Weather Sensor
- 17 Connecting a Hunter Remote
- 19 Connecting to the Hunter Solar Sync®

Programming the Controller

- 20 Setting the Current Date and Time
- 21 Setting Program Start Times
- 22 Setting Station Run Times (Length of Watering for Each Area)
- 23 Setting a Watering Schedule
- 25 Options for Running Your Irrigation System
- 27 Using the Pro-C to Operate Outdoor Lighting

Advanced Features

- 29 Set Pump/Master Valve Operation
- 29 Programmable Rain Off
- 29 Setting Specific Days Off

Hidden Features

- 30 Program Customization
- 30 Programmable Delay Between Stations
- 31 Programmable Sensor Override
- 32 Total Run Time Calculator
- 32 Easy Retrieve™ Program Memory
- 33 Solar Sync Delay
- 34 Cycle and Soak
- 36 Hunter Quick Check™
- 36 Clearing Controller’s Memory/Resetting Controller
- 36 Winterizing Your Irrigation System

Troubleshooting Guide

- 37 Problems, Causes and Solutions

Quick Check and Easy Retrieve are trademarks of Hunter Industries, Inc.

Pro-C, Solar Sync, Rain-Clik, Freeze-Clik and SmartPort are registered trademarks of Hunter Industries, Inc.

Specifications

Operating Specifications

- **Station Run Time:** 1 minute to 6 hours on programs A, B, and C
- **Start Times:** 4 per day, per program, for up to 12 daily starts
- **Watering Schedule:** 7-day calendar, interval watering up to a 31-day interval or true odd or even day programming, made possible by the 365-day clock/calendar

Electrical Specifications

- **Transformer Input:** 120 VAC, 60 hz (230 VAC, 50/60 hz International Use)
- **Transformer Output:** 24 VAC, 1 Amp
- **Station Output:** 24 VAC, 0.56 amps per station
- **Maximum Output:** 24 VAC, 0.84 amps (includes Master Valve Circuit)
- **Battery:** 9-volt alkaline battery (not included) used only for non-AC programming, the non-volatile memory maintains program information
- Battery, front panel, internal CR2032 Lithium for real-time clock

Cabinet Dimensions

Height: 9" (23 cm)
Width: 10" (21.5 cm)
Depth: 4.5" (10.9 cm)

Outdoor cabinet is NEMA 3R, IP44 rated.

Default Settings

All stations are set to zero run time. This controller has a non-volatile memory that retains all entered program data even during power outages, without need for a battery.

Cleaning



Clean only with cloth dampened with mild soapy water.

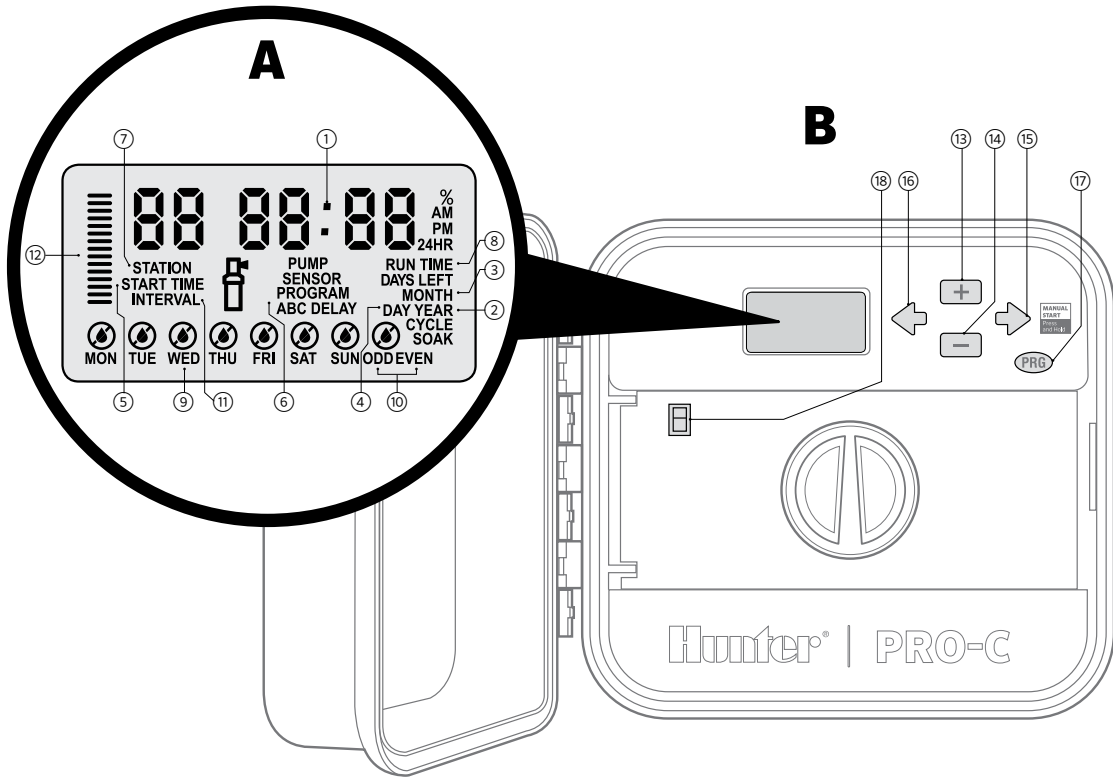



Pro-C Components



Pro-C Components *(continued)*

A LCD Display	
① Main Display	Indicates various times, values, and programmed information
② Year	Identifies current calendar year
③ Month	Identifies current calendar month
④ Day	Identifies current calendar day
⑤ Start Time	Identifies selected program start time
⑥ Program Selector	Identifies the program in use: A, B, or C
⑦ Station Number	Identifies currently selected station number
⑧ Run Time	Allows user to set each valve station run time from 1 minute to 4 hours
⑨ Days of the Week	Identifies days of the week to water or not water
⑩ Odd/Even Watering	Identifies if odd or even watering days are selected
⑪ Interval	Identifies if interval watering has been selected
⑫ Seasonal Adjustment	Displays in increments of 5%, the percentage of seasonal adjust that has been selected

 Running	Sprinkler icon indicates when watering is occurring
 Rain Drop	Indicates watering will occur on selected day
 Crossed Rain Drop	Indicates watering will NOT occur on selected day

B Control Buttons and Switches	
⑬  Button	Increases the selected flashing display
⑭  Button	Decreases the selected flashing display
⑮  Button	Advances the selected flashing display to the next item, also use to start a manual cycle
⑯  Button	Returns selected flashing display to the previous item
⑰  Button	Selects programs A, B, and C; also to start a test program
⑱ Rain Sensor Bypass Switch	Use to bypass weather “Clik-type” sensors if one is installed

Pro-C Components *(continued)*

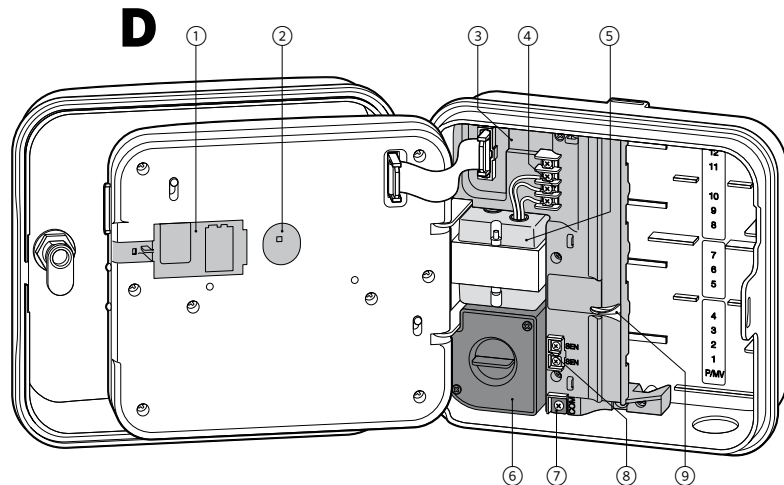
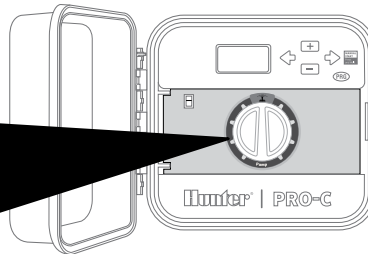
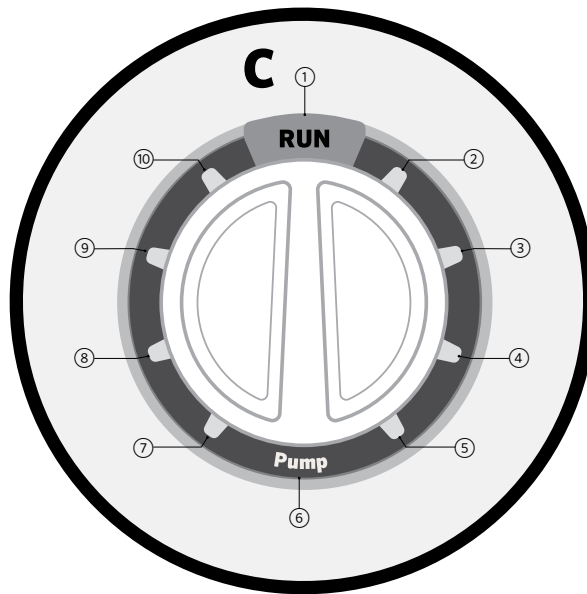

Pro-C Components *(continued)*

C Control Dial	
① Run	Normal dial position for automatic operation
② Set Current Date/Time	Set current date and time
③ Set Program Start Times	Set 1 to 4 start times in each program
④ Set Station Run Times	Set each station run time
⑤ Set Days to Water	Select individual days to water, odd, even or interval watering schedule
⑥ Set Pump Operation	Turn pump or master valve on or off for each station
⑦ Seasonal Adjustment	Make global run time changes without programming the controller (from 5% to 300%)
⑧ Solar Sync®	Allows user to program settings when using Solar Sync ET sensor
⑨ Manual—Single Station	Activates a one time watering of a single station
⑩ System Off	Used to discontinue all programs and stop all watering until the dial is returned to the RUN position, or to set the programmable rain off feature

D Wiring Compartment	
① 9-Volt Battery	An alkaline battery (not included) allows programming of the controller without AC power
② Reset Button	This button will reset the controller. All programmed data will remain intact
③ Power Area	Used to attach transformer, sensor wires, and other systems to the controller
④ SmartPort® Input Terminals	Used to connect a SmartPort, which enables Hunter remote controls
⑤ Transformer	A transformer is installed (Outdoor models only, indoor models are supplied with a plug-in transformer)
⑥ Junction Box	This box provides an area for connecting primary AC power (Outdoor models only)
⑦ Ground Lug	For additional surge protection, connect lug to earth ground
⑧ Sensor Terminals	Used to connect Hunter Solar Sync or “Clik-type” sensors
⑨ Power Slide	Release to remove or insert Pro-C modules

Mounting the Controller to a Wall

All necessary hardware is included for most installations.

1. Use the hole at the top of the controller as a reference and secure a 1" (25 mm) screw into the wall. **Note: Install screw anchors if attaching to drywall or masonry wall.**
2. Align controller with the screw and slide the keyhole on top of the controller over the screw.
3. Secure controller in place by installing screws in the holes.

For PC-401-A: If the supply cord is damaged, it must be replaced by the manufacturer or service agent or a similarly qualified person in order to avoid hazard.



The **indoor** Pro-C is not weather or water resistant, and must be installed indoors or in a protected area. This device is not intended for use by young children. Never let children play with this device.

Outdoor model is water and weather resistant. Connecting the outdoor Pro-C to the primary power should be done by a licensed electrician following all local codes. Improper installation could result in shock or fire hazard. This device is not intended for use by young children. Never let children play with this device.

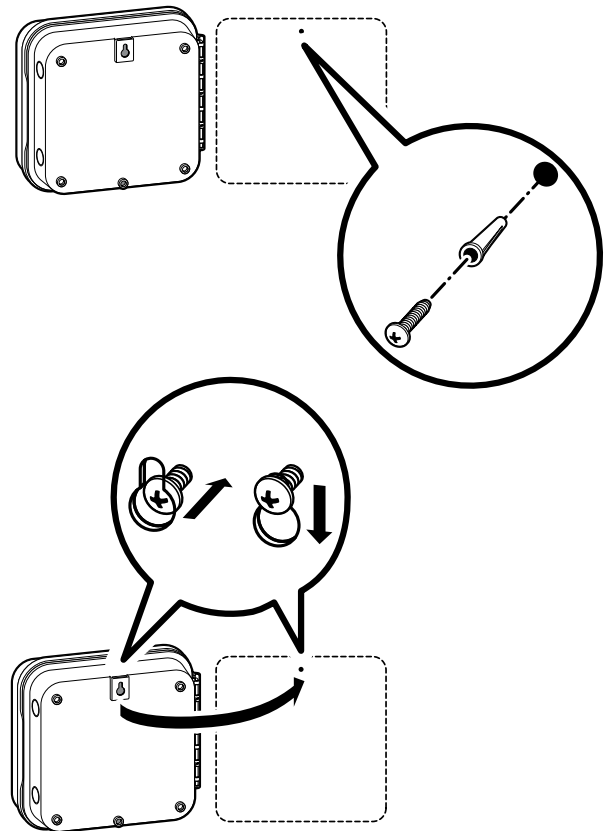

Connecting AC Power

Indoor Cabinet

Route transformer cable through the hole on the bottom left side of the controller and connect one **Yellow Wire** to each of the screws marked **AC** and the **Green Wire** to **GND**.

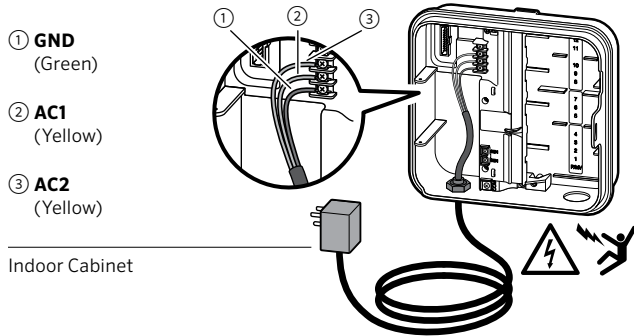

Indoor Cabinet

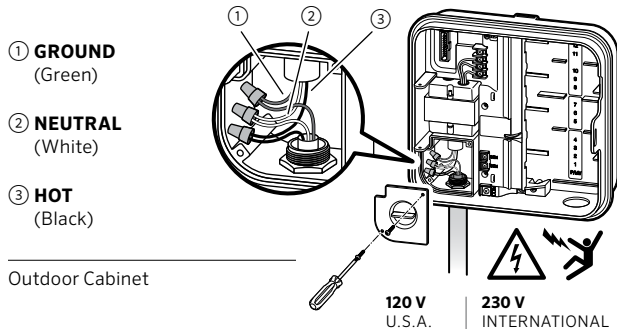

Outdoor Cabinet



To be performed by a licensed electrician only.

Always use UL listed ½" (13 mm) conduit with male adapter when installing AC wiring. Pro-C/PCC controllers are intended to be supplied AC power with a 15A rated overcurrent protected device.

Outdoor Cabinet

1. Route **AC** power cable and conduit through the ½" (13 mm) conduit opening on the left side of the bottom of the cabinet.
2. Connect the wires to the transformer wires located inside the junction box. International units are supplied with a built in terminal strip. Always use a UL listed conduit ½" (13 mm) male adapter when installing the **AC** wiring.
3. Insert the adapter into the ½" (13 mm) hole at the bottom of the controller. Attach a nut to the adapter inside the enclosure.
4. Connect a 9-volt **alkaline** battery (not included) to the battery terminals and place in the battery compartment in the front panel. The battery allows the user to program the controller without AC power. **Watering will not occur without AC power.** Since this controller has non-volatile memory, the program clock and calendar will be retained during a power outage even if no battery is installed.

Installing Station Modules

The Pro-C controller is supplied with a factory-installed base module for up to 4 stations. Additional modules may be added in increments of 3 stations (PCM-300) or a single 9-station (PCM-900) to expand the controller's station capability to 16 stations. Additional modules are sold separately.

The Pro-C utilizes automatic module recognition firmware to identify when PCM modules are installed or removed from the controller. This feature will recognize the correct number of stations without having to reset or cycle power to the controller.

Installing PCM Modules

The Pro-C controller is designed with a simple to use “**Power Lock**” feature that assures that the modules are energized and firmly secured into the controller. The “**Power Lock**” can unlock or lock all modules at one time by simply pushing the “**Power Lock**” slide.

1. Slide the “**Power Lock**” into the “**Power Off**” (unlocked) position. Insert the PCM modules into the appropriate sequential position in the controller cabinet.
2. Once all of the modules are in place, slide the “**Power Lock**” into the “**Power On**” (locked) position to energize and secure the modules into the controller.
3. The Pro-C will automatically recognize the correct number of stations. It is not necessary to press the reset button or cycle power to the controller.

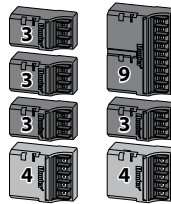
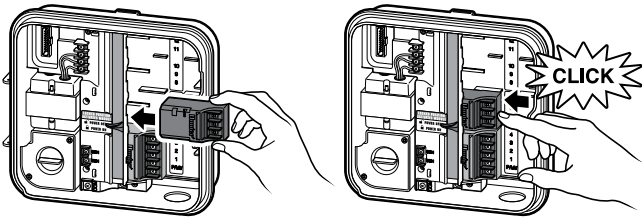

NOTE

The use of a PCM-900 to expand your controller to 16 stations requires that one PCM-300 be installed in the first expansion slot (**stations 5-7**) and the PCM-900 in the upper two expansion slots.

Connecting Station Wires

1. Route valve wires between control valve location and controller.
2. At valves, attach a common wire to either solenoid wire of all valves. This is most commonly a white colored wire. Attach a separate control wire to the remaining wire of each valve. All wire splice connections should be done using waterproof connectors.
3. Route valve wires through the conduit and attach conduit to one of the openings on the bottom of the cabinet.
4. Strip $\frac{1}{2}$ " (13 mm) of insulation from ends of all wires. Secure the valve common wire to "COM" (Common) terminal. Attach all individual valve control wires to the appropriate station terminals.



NOTE

Common terminal screw has moved from base module and is now below the sensor terminals. Do not connect the incoming common wires to the PM/V terminal.

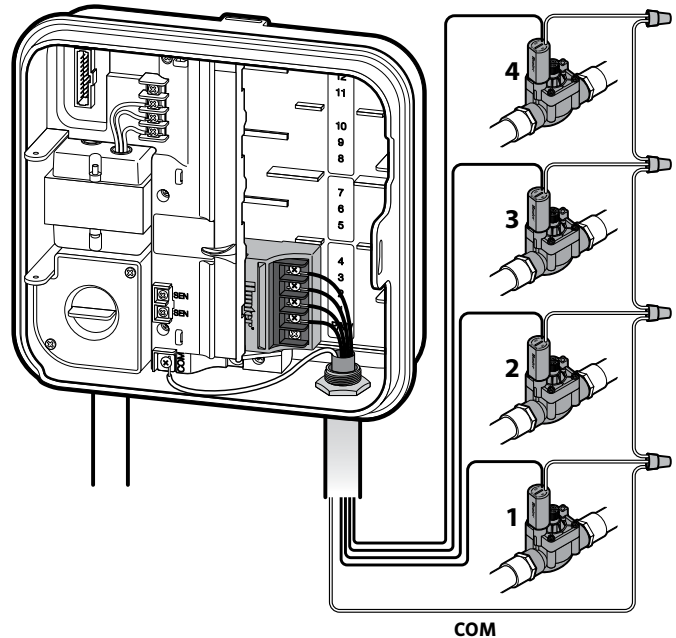

Connecting the Battery (optional)



WARNING: RISK OF FIRE, EXPLOSION, AND ELECTRIC SHOCK. REPLACE BATTERY WITH CR2035 TYPE ONLY. Use of a different battery has potential for a risk of fire, explosion, and electric shock. See owner's manual for instructions.

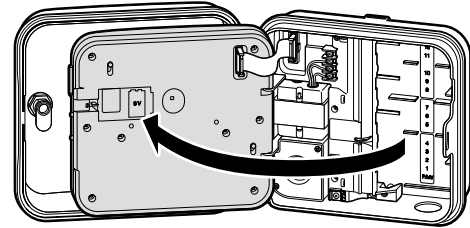

Connect a 9-volt **alkaline** battery (not included) to the battery terminals and place in the battery compartment in the front panel. The battery allows the user to program the controller without AC power. **Watering will not occur without AC power.** Since this controller has non-volatile memory, the program clock and calendar will be retained during a power outage even if no battery is installed.

Activating the 3V Lithium Battery

After installing your Pro-C, make sure to remove the battery contact insulator to allow the Pro-C to keep time in the event of a power outage.



NOTE

When installing 3V Lithium battery, ensure the positive (+) side is facing up.

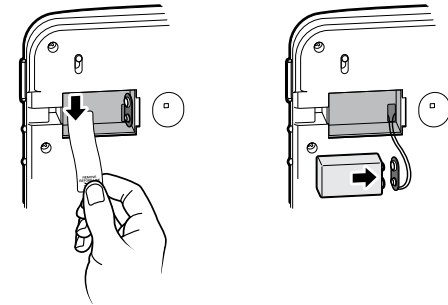

Replacing the 3V Lithium Battery

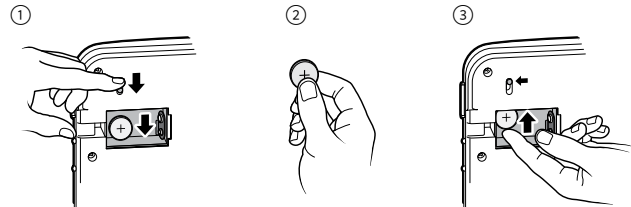

Connecting a Master Valve *(optional)*

Connect either wire from Master Valve to the **P/MV** terminal.
Connect remaining wire to the **“COM”** (Common) terminal.

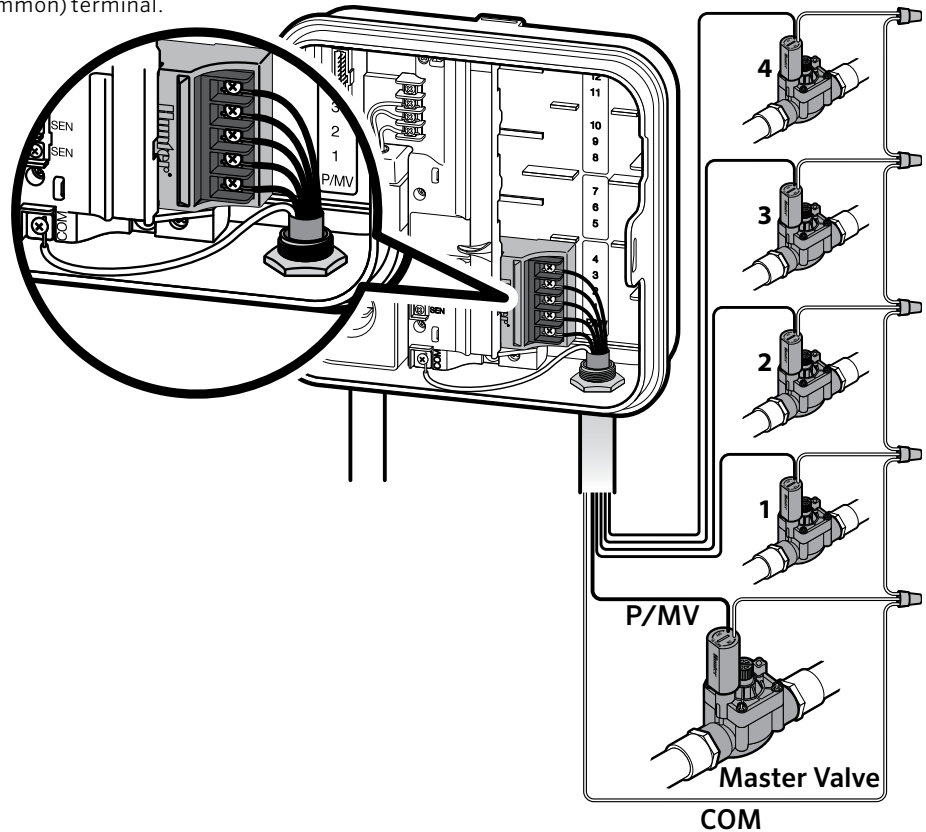

Connecting a Pump Start Relay *(optional)*

1. Route a wire pair from the pump relay into the controller housing.
2. Connect the pump common wire to the terminal slot “COM” (Common) and the remaining wire from the pump relay to the P/MV terminal slot.

Relay holding current draw must not exceed 0.28 amps (24 VAC). **Do not connect the controller directly to the pump—damage to controller will result.**

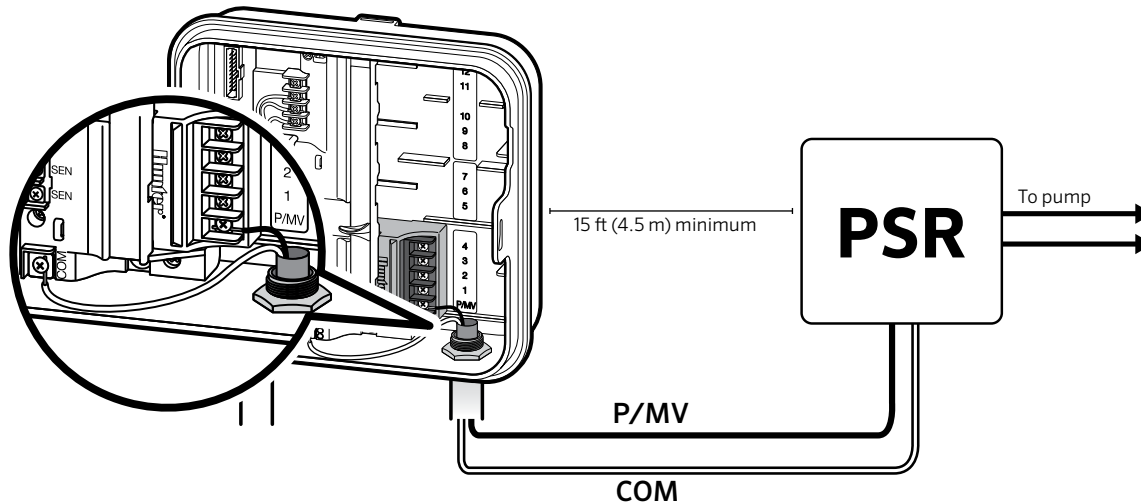

Connecting a Hunter “Clik” Weather Sensor *(not included)*

A Hunter weather sensor or other micro-switch type weather sensors can be connected to the Pro-C. The purpose of this sensor is to stop automatic watering when weather conditions dictate.

1. Remove the metal jumper plate that is attached across the two **SEN** terminals inside the controller.
2. Connect one wire to one **SEN** terminal, and the other wire to the other **SEN** terminal.

When the weather sensor has deactivated automatic watering, “**OFF**” will appear on the display.

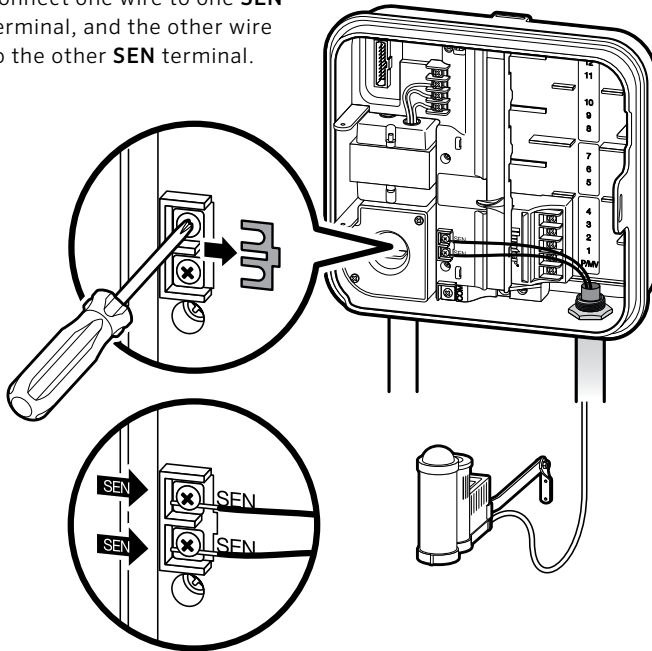
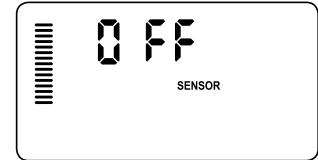

Connecting a Hunter “Clik” Weather Sensor *(continued)*

Testing the Weather Sensor

The Pro-C provides simplified testing of a rain sensor when the sensor is wired into the sensor circuit. You can manually test proper operation of the rain sensor by using the One Touch Manual Start (see page 26). During the Manual cycle, pressing the test button on the “Clik-type” sensor (eg. Mini-Clik®) will interrupt watering.

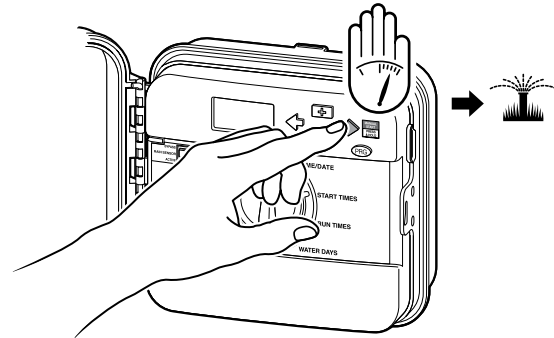

 **NOTE**

The Manual single station function ignores any attached sensor and will allow watering to occur.

Manually Bypassing the Weather Sensor

If the rain sensor is interrupting irrigation, you can bypass it by using the bypass switch on the front of the controller.

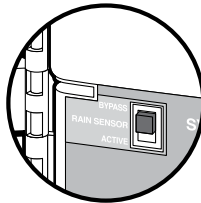

Slide the switch to the **Bypass** position to disable the rain sensor from the system to allow for controller operation. You can also bypass the weather sensor for manual operation by using the **Manual** function.

The Bypass switch does not affect the Seasonal Adjust update when using the Solar Sync sensor.

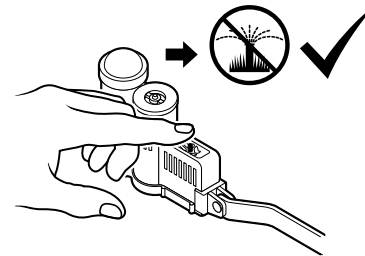

Connecting a Hunter Remote *(not included)*

The Pro-C is compatible with Hunter remote controls. The SmartPort wiring harness (included with all Hunter remotes) allows for fast and easy use of Hunter controls. Hunter remotes make it possible for you to operate the system without having to walk back and forth to the controller.

To Install the SmartPort Connector

1. Install a ½" (13 mm) female threaded "Tee" in the field wiring conduit approximately 12" (30 cm) below the Pro-C.
2. Feed the red, white, and blue wires of the harness through the base of the "Tee" and into the wiring compartment as shown.
3. Screw the SmartPort harness housing into the "Tee" as shown.

4. Attach the **red** wire to the screw slot marked **AC1**, attach the **white** wire to the screw slot marked **AC2**, attach the **blue** wire to the screw slot marked **REM**.



NOTE

Reversing the red and white wires will result in an "SP ERR" message.



NOTE

P/N 258200 can be used as an alternate method to mount the SmartPort connector.

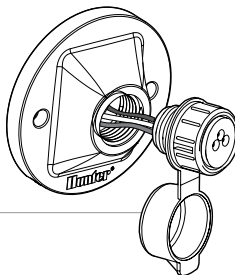

Connecting a Hunter Remote (continued)

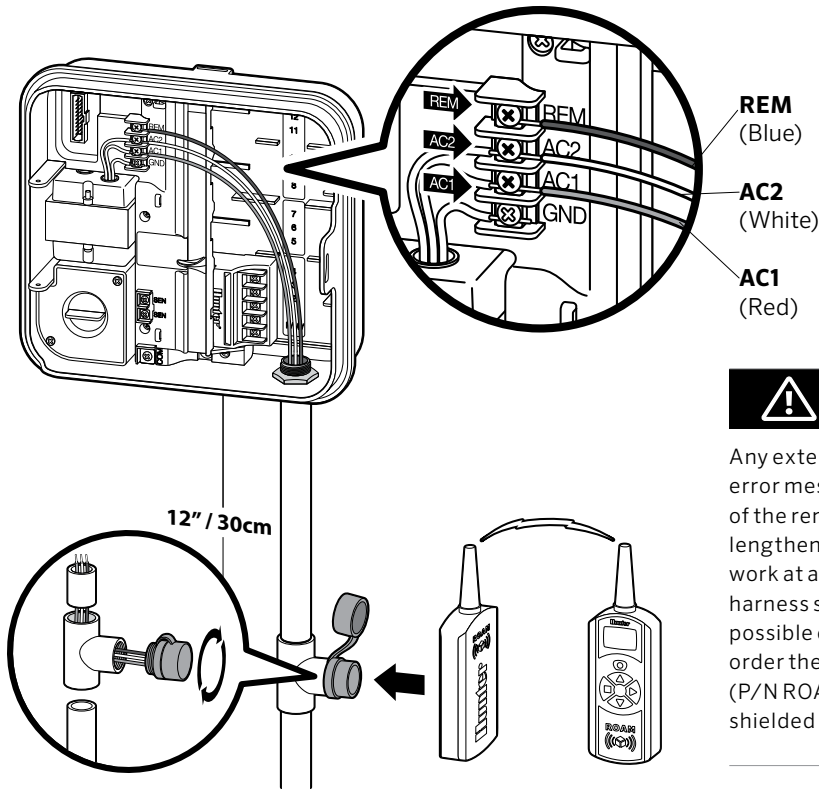

NOTE

Any extension of the wiring on the SmartPort® may result in an error message in the controller display and possible malfunction of the remote unit due to radio interference. In some situations, lengthening of the harness may work fine, in others it may not work at all (it is site specific). In either case, extending the wiring harness should be done using shielded cable to minimize the possible effects of electrical noise. For easiest installation, order the Hunter SmartPort shielded cable wiring harness (P/N ROAM-SCWH) with a full 25 feet (7.6 meters) of shielded cable.

Connecting to the Hunter Solar Sync[®]

The Solar Sync is a sensor system that, when connected to Hunter Pro-C, will automatically adjust your controller watering based upon changes in local climate conditions. The Solar Sync utilizes a solar and temperature sensor to measure on-site weather conditions used to determine evapotranspiration (ET), or the rate at which plants and turf use water. In addition, the Solar Sync sensor includes a Hunter Rain-Clik and Freeze-Clik sensor that will shut down your irrigation system when it rains and/or during freezing conditions.

The controller will automatically increase or decrease watering run times based on changes in weather. The result is a new water-efficient irrigation product that promotes water conservation and healthier plants. You simply program your controller like you normally would, and the Solar Sync takes over from there, eliminating the need to manually adjust your watering schedule.

For installation and programming instructions of your Hunter Solar Sync, please refer to the Solar Sync owner's manual.

Setting the Current Date and Time

1. Turn the dial to the **DATE/TIME** position.
2. The current year will be flashing in the display. Use the **+** and **-** buttons to change the year. Push the **➔** button to proceed to setting the month.
3. The month will be flashing. Use the **+** and **-** buttons to change the month. Press the **➔** button to proceed to setting the day.
4. The day will be flashing. Use the **+** and **-** buttons to change the day of the month. Press the **➔** button to proceed to setting the time.
5. The time will be displayed: Use the **+** and **-** buttons to select AM, PM, or 24 hr. Press the **➔** button to move to hours. Use the **+** and **-** buttons to change the hour shown on the display. Press the **➔** button to move onto the minutes. Use the **+** and **-** buttons to change the minutes shown in the display.

The date and time have now been set.

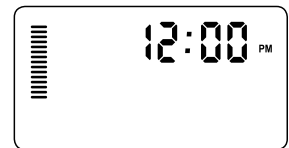
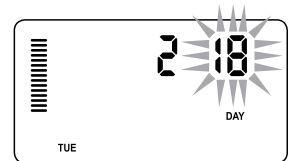
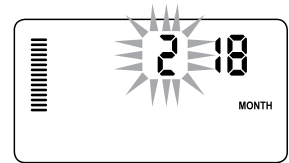

Setting Program Start Times

1. Turn the dial to the **START TIMES** position.
2. Press the **PRG** button to select **A**, **B**, or **C**.
3. Use the **+** and **-** buttons to change the start time. (Advances in 15-minute increments.) **One start time will activate all stations sequentially in that program.** This eliminates the need to enter a start time for each station.
4. Press the **→** button to add an additional start time, or **PRG** button for the next program.

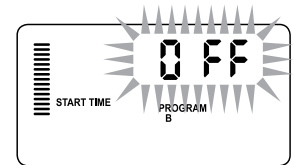
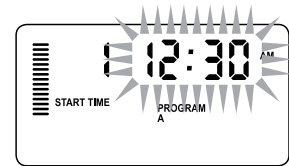
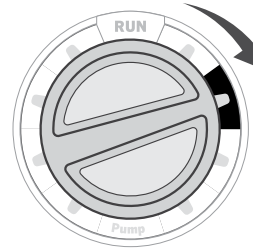

Eliminating a Program Start Time

With the dial set to the **START TIMES** position, push the **+** and **-** buttons until you reach 12:00 AM (Midnight). From this position push the **-** button once to reach the “**OFF**” position.



All stations operate in numerical order. **Only one program start time is required to activate a watering program.**

If a program has all four start times turned off, then that program is off (all other program details are retained). Because there are no start times, there will be no watering with that program.

Setting Station Run Times

1. Turn the dial to the **RUN TIMES** position.
2. The display will show the last program selected (**A, B, or C**) the station number selected, and the run time for that station will be flashing. You can switch to another program by pressing the **PRG** button.
3. Use the **+** and **-** buttons to change the station run time on the display. You may set station run times from 1 minute to 6 hours.
4. Press the **→** button to advance to the next station.
5. Repeat steps 2 and 3 for each station.

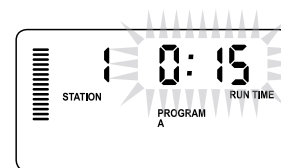
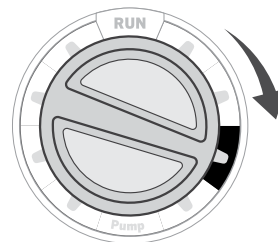

Setting a Watering Schedule

1. Turn the dial to the **WATER DAYS** position.
2. The display will show the last program selected (**A**, **B**, or **C**). You can switch to another program by pressing the **PRG** button.
3. The controller displays currently programmed active day schedule information. You can choose to water on specific days of the week, or you can choose interval watering, or choose to water on odd days or even days. Each program can operate using only one type of water day option.

Selecting Specific Days of the Week to Water

1. Press the **▶** button to activate a particular day of the week to water (the display always starts with Monday). Press the **◻** button to cancel watering for that day. After pressing a button the display automatically advances to the next day. A **▲** icon indicates a water day. A **●** icon indicates a no water day.
2. After programming, set dial to the **RUN** position to enable automatic execution of all selected programs and start times.

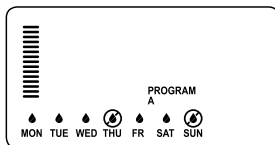
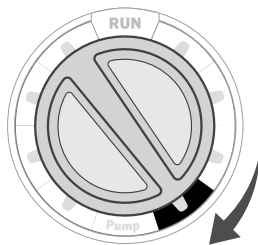

Selecting Odd or Even Days to Water

This feature uses numbered day(s) of the month for watering instead of specific days of the week (odd days: 1st, 3rd, 5th, etc.; even days: 2nd, 4th, 6th, etc.)

1. With the **▲** cursor on **SUN** press the **▶** button once. **ODD** will flash on the screen.
2. If even day watering is desired, press the **◻** button once. **EVEN** will flash on the screen. You can move back and forth from **ODD** to **EVEN** by pressing the **◻** button.
3. Once odd or even day watering is chosen, turn the dial back to the **RUN TIMES** position to set watering days.

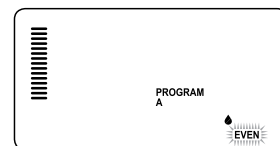
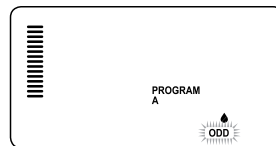

Setting a Watering Schedule *(continued)*

Selecting Interval Watering

This feature is convenient if you want to have a more consistent watering schedule without having to worry about the day of the week or the date. The interval you select is the amount of days between watering including the watering day.

1. Turn the dial to the **WATER DAYS** position. The water drop above Monday should be flashing.
2. Press the **➔** button until **EVEN** is flashing, then press the **➔** button one more time. The display will change to the interval mode and the Interval Day number will be flashing.
3. Press the **⊕** button. The display will now show two numbers: the interval, and the days remaining in the interval.
4. The number of days between waterings, or the interval, will be flashing. Use the **⊕** and **⊖** buttons to select the number of days desired between waterings.
5. Press the **➔** button. The days remaining in the interval are now flashing. Use the **⊕** and **⊖** buttons to select the number of days until the next desired watering. One day remaining means it will water the next day.



NOTE

If any days are selected as non-water days  at the bottom of the display, the Interval Day watering will exclude those days. For example, if the Interval Days are set at 5 and Monday is a non-water day, the controller will water every 5th day, but never on a Monday. If the interval water day falls on a Monday and Monday is a non-water day, the program would not water for 5 more days resulting in no irrigation for 10 days total.

Options for Running Your Irrigation System

Run

After programming is complete, turn the dial to the **RUN** position to enable automatic execution of all selected programs and start times.

System Off

Valves currently watering will be shut off after the dial is turned to the **SYSTEM OFF** position for two seconds. All active programs are discontinued and watering is stopped. To return controller to normal automatic operation, simply return dial to the **RUN** position.

Manually Run a Single Station

1. Turn the dial to the **MANUAL** position.
2. Station run time will flash in the display. Use the **➔** button to move to the desired station. You may then use the **+** and **-** buttons to select the amount of time for a station to water.
3. Turn the dial to the **RUN** position to run the station (only the designated station will water, then controller will return to automatic mode with no change in the previously set program).

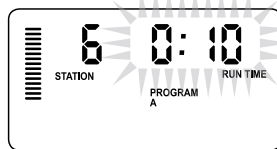
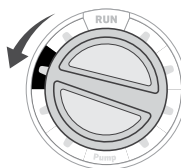

Seasonal Adjustment

Seasonal Adjust is used to make global run time changes without re-programming the entire controller. This feature is perfect for making small changes that are necessary as the weather changes. For instance, hotter times of the year may require a bit more water. Seasonal adjust can be increased so that the stations will run longer than the programmed time. Conversely, as Fall approaches, the seasonal adjust can be reduced to allow for short watering durations.



1. Turn the dial to the **SEASONAL ADJUST** position.
2. Press the **+** or **-** buttons to set the percentage desired from 5% to 300%.

To view the new adjusted run time, turn the dial to set run time's position. The displayed run times will be updated accordingly as the seasonal adjustment is made.



The controller should always be initially programmed in the 100% position.



The Manual single station function ignores any attached sensor and will allow watering to occur.

Options for Running Your Irrigation System *(continued)*

One Touch Manual Start and Advance

You can also activate a program to water without using the dial.

1. With the dial in the **RUN** position, hold down the ➔ button for 2 seconds.
2. This feature automatically defaults to program **A**. You can select program **B**, or **C** by pressing the **PRG** program.
3. The station number will be flashing. Press the ⬅ or ➡ button to scroll through the stations and use the **+** and **-** buttons to adjust the station run times. (If no buttons are pressed during step 2 or 3, the controller will automatically begin program **A**.)
4. Press the ➔ button to scroll to the station you wish to begin with. After a 2 second pause, the program will begin.

This feature is great for a quick cycle when extra watering is needed or if you would like to scroll through the stations to inspect your system.

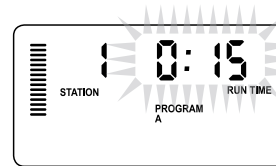
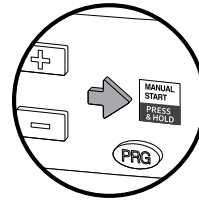

Using the Pro-C to Operate Outdoor Lighting *(optional)*

Connecting the FX Transformer

The Pro-C is capable of operating three separate lighting transformers equipped with the PXSynC interface box. Connect wires from the first PXSynC box to station output 1 (and the Common) on the Pro-C terminal. If using a second or third transformer, the second will be wired to station 2 and the third will be wired to station 3.



Manual cycles initiated at the controller or from a remote will cancel any automatic program currently running. Once manual cycle is complete, the controller will return to automatic mode, and run the next scheduled program at its specified start time.

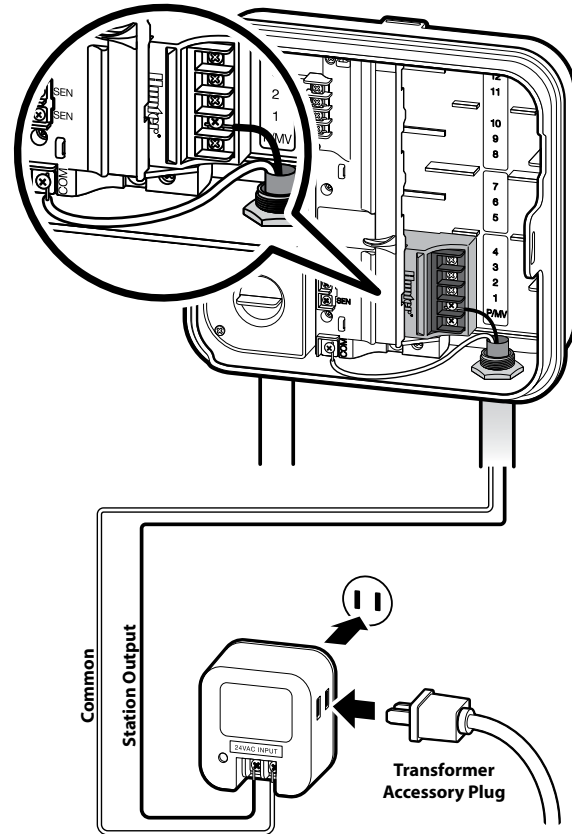

Using the Pro-C to Operate Outdoor Lighting *(optional)*

Creating a Lighting Program

1. Turn the dial to the **START TIMES** position.
2. Press and hold the **PRG** button for 6 seconds and observe the **A, B, C** programs moving.
3. **L1** and a flashing “**OFF**” will appear, and the controller is ready to designate lighting programs.
4. Add a start time to lighting program L1 by pressing the **+** and **-** buttons until the correct time is shown. Up to four start times can be assigned to L1.
5. Turn the dial to the **RUN TIMES** position. Press the **PRG** button repeatedly until **L1** is shown. Use the **+** and **-** buttons to add a run time to lighting program L1.

If using a second or third lighting transformer, repeat the above process steps after connecting the additional PXSynC boxes and adding start and run times accordingly.

You do not need to program days of the week for lighting programs, as they run every day according to the programmed start and run times.



NOTE

Once a start time is assigned to program L1, it turns station 1 from an irrigation station to a lighting station (same for L2 and L3). As a result, when creating programs for irrigation A, B, or C, station 1 will show **USED** since L1 has been assigned a start time.

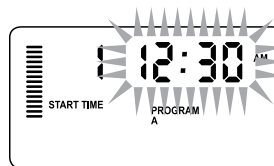
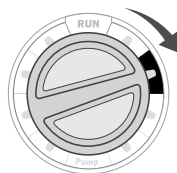

Example of screen upon entering

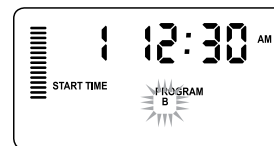
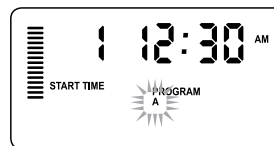

Example of flashing screen while holding down on **PRG** button

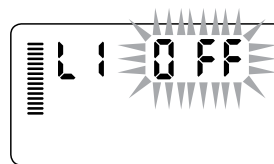

Lighting program can be activated

Advanced Features

Set Pump/Master Valve Operation

The default is for all stations to have the master valve/pump start circuit **ON**. The master valve/pump start can be set **ON** or **OFF** by station, regardless of which program the station is assigned.

To program pump operation:

1. Turn the dial to the **PUMP** position.
2. Press the **+** or **-** buttons to toggle the master valve/pump start **ON** or **OFF** for the specific station.
3. Press the **➡** button to advance to the next station.
4. Repeat steps 2 and 3 for all necessary stations.

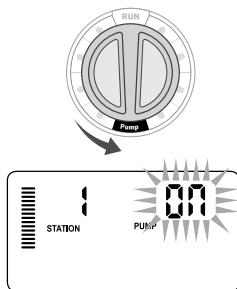

Programmable Rain Off

This feature permits the user to stop all programmed waterings for a designated period from 1 to 31 days. At the end of the programmable rain off period, the controller will resume normal automatic operation.

1. Turn the dial to the **SYSTEM OFF** position.
2. Press the **+** button and a 1 will be displayed and the **DAYS LEFT** icon will illuminate.
3. Press **+** as many times as needed to set the number of days off desired (up to 31).

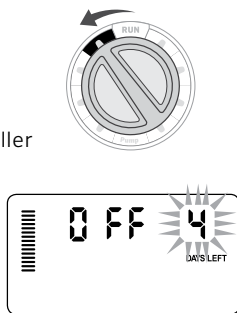

4. Turn the dial back to the **RUN** position, at which time, **OFF**, a number and the **DAYS** icon all remain on.
5. Leave the dial in the **RUN** position.

The days off remaining will decrease at midnight of each day. When it goes to zero, the display will show the normal time of day and normal irrigation will resume at the next scheduled start time.



Setting Specific Day(s) Off

Programming a No Water Day(s) is useful to inhibit watering on mowing days, etc. For instance, if you always mow the lawn on Saturdays you would designate Saturday as a No Water Day so you are not mowing wet grass.



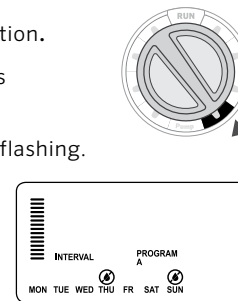

1. Turn the dial to the **WATER DAYS** position.
2. Enter an interval watering schedule as described on page 24.
3. Press the **➡** button once. **MON** will be flashing.
4. Use the **➡** button until the cursor is at the day of the week you wish to set as a No Water Day.
5. Press the **-** button to set this day as a no water day. The ☉ will illuminate over this day.
6. Repeat steps 4 and 5 until all desired event day(s) are off.



Hidden Features

Program Customization

The Pro-C is factory configured with 3 independent programs (A, B, C with four start times each) for different plant type requirements. The Pro-C can be customized to display only the required programs. You can hide those programs that are not required to ease programming.

1. Start with the dial in the **RUN** position.
2. Press and hold the  button. Turn the dial to the **WATER DAYS** position.
3. Release the  buttons.
4. Use the  and  button to change program modes.

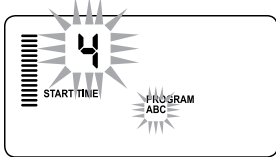

Advanced Mode

(3 programs / 4 start times)

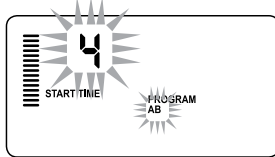

Normal Mode

(2 programs / 4 start times)

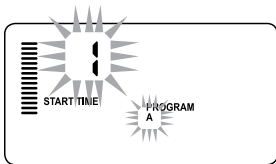





Limited Mode

(1 program / 1 start time)

Programmable Delay Between Stations

This feature allows the user to insert a delay between when one station turns off and the next station turns on. This is very helpful on systems with slow closing valves or on pump systems that are operating near maximum flow or have slow well recovery.

1. Start with the dial in the **RUN** position.
2. Press and hold the  button while turning the dial to the **RUN TIMES** position.
3. Release the  button. The display will show a delay time for all stations in seconds.
4. Press the  and  buttons to increase or decrease the delay time between 0 and 59 seconds in 1 second increments and then in one minute increments up to four hours. **Hr** will be displayed when the delay changes from seconds to minutes and hours. Maximum delay is 4 hours.
5. Return the dial to the **RUN** position.

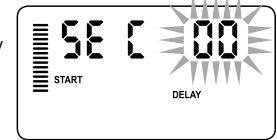





NOTE

The Master Valve/Pump Start circuit will operate during the first 15 seconds of any programmed delay to aid in the closing of the valve and to avoid unnecessary cycling of the pump.

Hidden Features *(continued)*



Programmable Sensor Override

The Pro-C allows the user to program the controller so that the sensor disables watering on only desired stations. For example, patio gardens that have pots under overhangs and roofs may not receive water when it rains and will continue to need to be watered during periods of rain. To program sensor override:

1. Turn the dial to the **RUN** position.
2. Press and hold the  button while turning the dial to the **START TIMES** position.
3. Release the  button. The display will show the station number, the **SENSOR** icon, and ON will be flashing.
4. Press the  or  button to enable or disable the sensor for the station shown.

ON = Sensor enabled (will suspend irrigation)

OFF = Sensor disabled (will allow watering)

5. Use the  or  buttons to scroll to the next station that you would like to program the sensor override.

A station that is running in the sensor override mode will display the word “**SENSOR**” and flash the  icon.

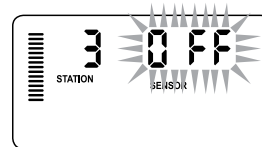
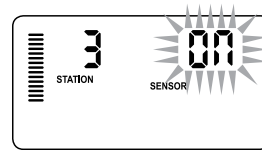

The controller default is for the sensor to disable watering on all zones when rain occurs.

Hidden Features *(continued)*

Total Run Time Calculator

The Pro-C keeps a running total of each program's station run times. This feature provides a quick way to determine how long each program will water.

1. While in the **RUN TIMES** mode use the **➔** button to advance to the highest station position.
2. Press the **➔** button once to review the total of all run times programmed.
3. Use the **PRG** button to review additional programs.

Test Program

The Pro-C allows the user a simplified method for running a test program. This feature operates each station in numerical sequence, from the lowest to the highest. You can start with any station. This is a great feature to check the operation of your irrigation system.

To initiate the test program:

1. Press and hold the **PRG** button. The station number will be flashing.
2. Press the **◀** or **➔** button to scroll to the station you would like the test program to start with. Use the **+** and **-** button to set a run time of up to 15 minutes. The run time needs to be entered only once.
3. After a 2 second pause, the test program will begin.

Easy Retrieve™ Program Memory

The Pro-C is capable of saving the preferred watering program into memory for retrieval at a later time. This feature allows for a quick way of resetting the controller to the original programmed watering schedule.

To save the program into memory:

1. With the dial in the **RUN** position, press and hold the **+** and **PRG** buttons for 3 seconds. The display will scroll **≡** from left to right across the display indicating the program is being saved into memory.
2. Release the **+** and **PRG** buttons.

To retrieve a program that was previously saved into memory:

1. With the dial in the **RUN** position, press and hold the **-** and **PRG** buttons for 3 seconds. The display will scroll **≡** from right to left across the display indicating the program is being retrieved from memory.
2. Release the **-** and **PRG** buttons.

Hidden Features *(continued)*

Solar Sync Delay for Pro-C

The delay feature is accessible only after the installation of the Solar Sync. The Solar Sync Delay feature allows the user to postpone seasonal adjustment changes from being made by Solar Sync for up to 99 days.

While the Solar Sync Delay is active, the Solar Sync will continue to collect and store data.

Operation:

To access the Solar Sync Delay setting:

1. Place the dial in the RUN position; press and hold the **+** button, rotate the dial to the Solar Sync position then release the **+** button. The following screen will be presented: **d:XX** (where **d** indicates days and **XX** indicates the number of days to be delayed).
2. Press the **+** or **-** button to increase/decrease the number of days the delay should run. Once the desired number of days is displayed, move the dial back to the **RUN** position to activate the delay.



NOTE

The number of days remaining will not be displayed on the **RUN** screen. To check if the Delay feature is active, open the Solar Sync Delay menu and check the days displayed. If 1 or more days are displayed, then Solar Sync Delay is active, if 00 is displayed then Solar Sync Delay is not active.

To change the existing Delay days setting:

1. Open the Solar Sync Delay menu by pressing the **+** button and rotating the dial to Solar Sync Settings and release the **+** button.
2. Use the **+** or **-** keys to modify the number of days until desired numbers of delay days is displayed. (Setting the days to 00 turns Solar Sync Delay to **OFF**.)
3. Return the dial to the **RUN** position for the changes to take effect.

While Solar Sync Delay is active, the Solar Sync will continue to gather weather information and calculate the Seasonal Adjust Value. The updated seasonal adjust will be applied once the Solar Sync Delay days reach 00.

Hidden Features *(continued)*

Cycle and Soak

The Cycle and Soak feature allows you to split a station's run time into more usable, shorter watering durations. This feature is useful when applying water to slopes and tight soils because it automatically applies water more slowly, helping to prevent runoff from occurring. You should enter the Cycle time as a fraction of the station's watering time, and the Soak time as the minimum number of minutes required before watering can occur again for the next Cycle. The total number of cycles is determined by taking the total programmed station run time and dividing it by the Cycle time.

Accessing the Cycle and Soak Menu:

The Cycle and Soak feature is accessed by placing the dial in the **RUN** position, pressing and holding the **+** button for 3 seconds; while holding the **+** button rotate the dial to the **RUN TIME** dial position, then release the button.

Setting the Cycle Time:

Initially Station 1 will be displayed. To access other stations, press the **←** or **→** button.

Once the desired station is displayed, use the **+** or **-** button to increase or decrease the Cycle time. The user can set the time from 1 minute to 4 hours in 1 minute increments or to **OFF** if no Cycle is desired.

 **NOTE**

Before 1 hour, only minutes are displayed (e.g. 36). At 1 hour or above, the display will change to include the hour digit (e.g. 1:13 and 4:00).

If a station's Run Time is less than or equal to the Cycle time, then no Cycle will be applied.

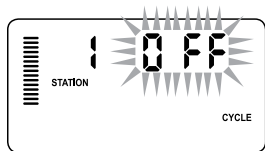

Example of Cycle screen upon entering

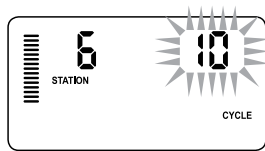

Example of Cycle screen with only minutes

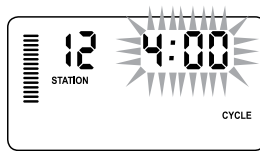

Example of Cycle screen with hours included

Hidden Features *(continued)*

Accessing the Soak Menu:

Once the desired Cycle times for each station have been programmed, the Cycle time can be accessed by pressing the **PRG** button.

The station will remain the same as was previously displayed under the Cycle time (i.e. if station 2 is displayed in the Cycle menu then Station 2 will be displayed upon pressing the **PRG** button).



The Soak menu cannot be accessed without a programmed Cycle time.

Setting the Soak Time:

To access the other stations, press the **←** or **→** button.



When changing the stations, if a station without a Cycle time is encountered, the screen will revert back to the Cycle time. Move to the next station with a Cycle Time and press the **PRG** button to return.

Once the desired station is displayed, the user can use the **+** or **-** button to increase or decrease the Soak time. The user can set the Soak time from 1 minute to 4 hours in 1 minute increments.



Before 1 hour, only minutes are displayed (e.g. 36). At 1 hour or above, the display will change to include the hour digit (e.g. 1:13 and 4:00).

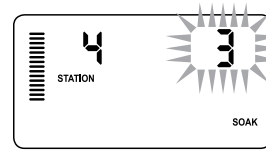

Example of Soak screen with only minutes

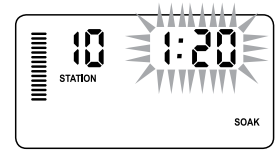

Example of Soak screen with hours included

Cycle and Soak Situations:

Station 1 requires 20 minutes of watering, but after 5 minutes, runoff occurs. However, after 10 minutes all the water is absorbed. The solution would be to program 20 minutes for the station run time, 5 minutes for the Cycle time, and 10 minutes for the Soak time.

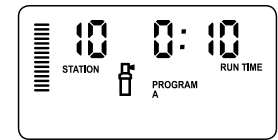

Station 10 cycle running

Hidden Features *(continued)*

Hunter Quick Check™

This circuit diagnostic procedure can quickly identify “shorts” commonly caused by faulty solenoids or when a bare common wire touches a bare station control wire.

To initiate the Hunter Quick Check test procedure:

1. Press the **+**, **-**, **←** and **→** buttons simultaneously. In the standby mode, the LCD will display all segments (helpful when troubleshooting display problems).
2. Press the **+** button to begin the Quick Check test procedure. The system will search all stations to detect a high current path through the station terminals. When a field wiring short is detected, an ERR symbol preceded by the station number will momentarily flash on the controller LCD display. After the Hunter Quick Check completes running this circuit diagnostic procedure, the controller returns to the automatic watering mode.

Clearing Controller’s Memory/Resetting Controller

If you feel that you have misprogrammed the controller, there is a process that will reset the memory to factory defaults and erase all programs and data that have been entered into the controller. Press and hold the **PRG** button. Press and release the **RESET** button on the back of the front panel. Wait until the display shows 12:00 am. Release the **PRG** button. The controller is now ready to be reprogrammed.



NOTE

Any programs that have been saved with Easy Retrieve will remain after resetting controller.

WINTERIZING YOUR SYSTEM

In regions where the frost level falls below the depth of the installed piping, it is common for systems to be “winterized”. Several methods can be used to drain the water from the system. If compressed air method is used, it is recommended that a qualified licensed contractor perform this type of winterization.



WARNING! WEAR ANSI APPROVED SAFETY EYE PROTECTION! Extreme care must always be taken when blowing out the system with compressed air. Compressed air can cause serious injury, including serious eye injury from flying debris. Always wear ANSI approved safety eye protection and do not stand over any irrigation components (pipes, sprinklers, and valves) during blow out. **SERIOUS PERSONAL INJURY MAY RESULT IF YOU DO NOT PROCEED AS RECOMMENDED.**

Troubleshooting Guide

Problem	Cause	Solution
The controller repeats itself or continuously waters, even when it should not be on (cycling repeatedly).	Too many start times (user error).	Only one start time per active program is required. Refer to “Setting Program Start Times” on page 21.
There is no display.	Check AC power wiring.	Correct any errors.
The display reads “SP ERR”.	Electrical noise is entering the system.	Check the SmartPort® wiring harness. Verify that the red wire is attached to the AC1 terminal, the white wire to the AC2 terminal and the blue wire to the REM terminal. If the wires were extended then they will need to be replaced with shielded cable. Contact your local distributor for information on shielded cable.
The display reads “P ERR”.	There is a fault in the pump start, master valve, or the wiring for the pump start/master valve.	Check the master valve or pump start wire for continuity. Replace or repair the shorted wire. Check that all wire connections are good and watertight.
The display reads a station number and ERR, such as “2 ERR”.	There is a fault in the station solenoid, or the station wiring.	Check the station wire for continuity. Replace or repair shorted wire. Check that all wire connections are good and watertight.
The display reads “NO AC”.	There is no AC power present (the controller is not receiving power).	Check to see if the transformer is properly installed.

Troubleshooting Guide *(continued)*

Problem	Cause	Solution
The display reads “SENSOR OFF”.	The rain sensor is interrupting irrigation or the sensor jumper is not installed.	Slide the Rain Sensor switch on front panel to the BYPASS position to bypass rain sensor circuit, or install the sensor jumper.
Rain sensor will not shut off system.	Incompatible rain sensor or the jumper was not removed when sensor was installed.	Make sure sensor is micro-switch type such as Mini-Clik®. Check that the jumper has been removed from the SEN terminals. Confirm proper operation (see “Testing the Weather Sensor” on page 16).
	Manual Single Station Mode Used.	Manual Single Station Mode will override the sensor. Use Manual All Station Mode to test sensor.
The controller does not have a start time for each station.	Programming error, dial in incorrect position.	Be sure the dial is in correct position. Total number of stations can be easily checked by placing dial in the RUN TIMES position and pressing the back arrow.
Valve will not turn on.	Short in wiring connections.	Check field wiring.
	Bad solenoid.	Replace solenoid.

Certificate of Conformity to European Directives

Hunter Industries declares that the irrigation controller Model Pro-C complies with the standards of the European Directives of “electromagnetic compatibility” 87/336/EEC and “low voltage” 73/23/EEC.



Senior Regulatory Compliance Engineer



FCC Notice

This controller generates radio frequency energy and may cause interference to radio and television reception. It has been type tested and found to comply with the limits for a Class B computing device in accordance with the specifications in Subpart J of Part 15 of FCC Rules, which are designed to provide reasonable protection against such interference in a residential installation. However, there is no guarantee that interference will not occur in a particular installation. If this equipment does cause interference to radio or television reception, which can be determined by turning the equipment off and on, the user is encouraged to try to correct the interference by one or more of the following measures:

- Reorient the receiving antenna
- Move the controller away from the receiver
- Plug the controller into a different outlet so that controller and receiver are on different branch circuits

If necessary, the user should consult the dealer or an experienced radio/television technician for additional suggestions. The user may find the following booklet prepared by the Federal Communications Commission helpful: “How to Identify and Resolve Radio-TV Interference Problems.” This booklet is available from the U.S. Government Printing Office, Washington, D.C., Stock No. 004-000-00345-4 (price: \$2.00)

This product should not be used for anything other than what is described in this document. This product should only be serviced by trained and authorized personnel.

HUNTER INDUSTRIES INCORPORATED | *Built on Innovation*[®]

1940 Diamond Street, San Marcos, California 92078 USA

www.hunterindustries.com

LIT-605_ENG 1/14