

GALCON 9001D

Computerized Irrigation Controller Installation & Operation I n s t r u c t i o n s

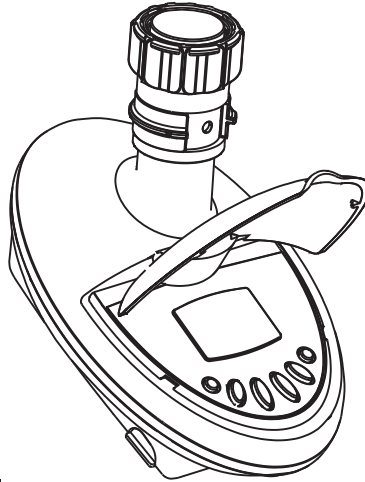

Israel's Leading Manufacturers of Irrigation Controllers

Kfar-Blum 12150, Tel. 972-4-690-0222, Fax. 972-4-690-2727
E-Mail: info@galcon.co.il, www.galcon.co.il

1. PARTS IDENTIFICATION

HOSE END TIMER

1. Female swivel hose thread faucet/tap adapter
2. Interior filter
3. Top cover
4. Controller display
5. Programming and operation buttons
6. Male hose thread connection
7. Battery compartment

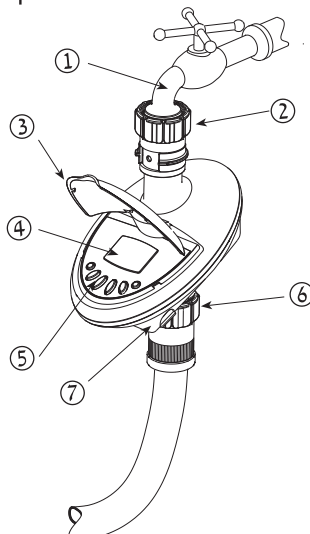

2. BATTERY INSTALLATION

- Hold the controller with the battery compartment facing you
- Remove the battery compartment cover
- Connect 9V battery to the battery connector
- Insert battery and press on battery cover
- Pay attention: when changing the battery, make sure the battery compartment stays dry.

Use Alkaline batteries only.

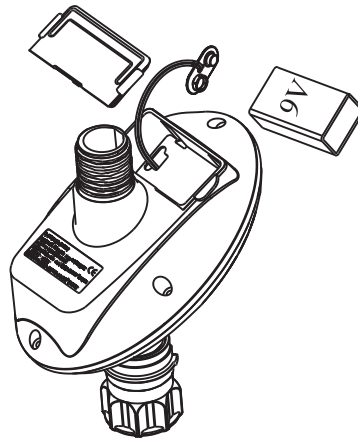

2

3. CONTROLLER/TIMER INSTALLATION

Make sure the filter (washer) is in place, then screw the controller to the faucet/tap by attaching the side with the female swivel hose thread connector to the faucet or hose end, then turn it clockwise (hand tighten only). Connect the controller hose male thread side to your system.

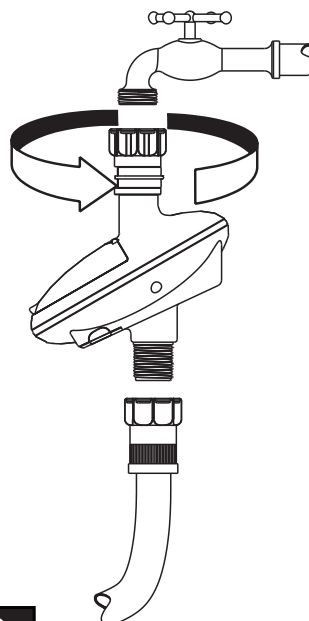

3

4. IRRIGATION PROGRAMMING

This section contains an example of weekly irrigation program. Simply alter data in the example to adapt the program to meet your irrigation requirements.

The digital controller is programmed with the aid of 4 buttons.

- ⌂ Programming step – used to select the appropriate programming mode (e.g. clock setting mode).
- ⇒ Parameter selection – used to select the parameter to be changed (e.g. hour, minute, etc.) To implement the change, the selected parameter must be blinking.
- + Data increment (increase) – raises the value of the selected parameter (e.g. adds an hour)
- Data decrement (decrease) – lowers the value of the selected parameter (e.g. deducts an hour).

4

If no changes are implemented, the controller display will always revert to the main screen (clock).

Display digits will stop blinking after 40 seconds. If the last parameter stops blinking before you have completed your programming, press ⌂ to continue the process.





Emergency Irrigation: After inserting batteries if no buttons are pressed, the clock will blink continuously. After 10 minutes, the controller will implement 5-minute irrigation on a 24-hour cycle.

SETTING CURRENT TIME & DAY OF THE WEEK



Setting The Clock

To enable the irrigation controller to operate the irrigation system at the required times, the current time and day of the week must be set as shown below:

5

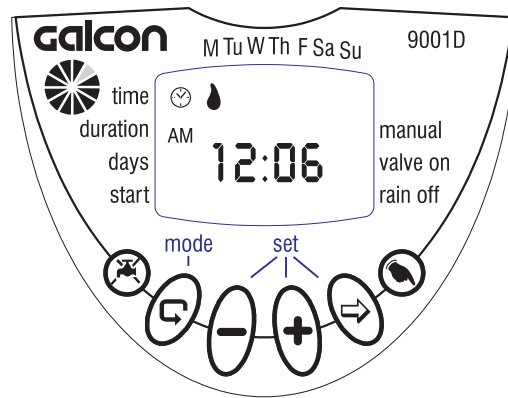

1. Press  several times until  appears.
2. Press . The hour digits blink. Set the current hour with the aid of  or .





3. Press . The minute digits blink. Set the current minute with the aid of  or .

6

Setting The Day Of The Week

1. Press  until a blinking drop appears at the top of the display.
2. Set the drop on the current day of the week by pressing on  or .

For a 24 hour clock display, press concurrently on  and  buttons once the hour digits stop blinking.







Pressing these buttons again will revert the display back to AM/PM hour display.

7

PROGRAMMING A WEEKLY IRRIGATION SCHEDULE (SET DAYS OF THE WEEK)

Let's assume that we want to program the irrigation controller to water three times a day, at 8:00 a.m., 1:00 p.m. and 7:00 p.m., for 10 minutes each time, on Tuesday and Friday.





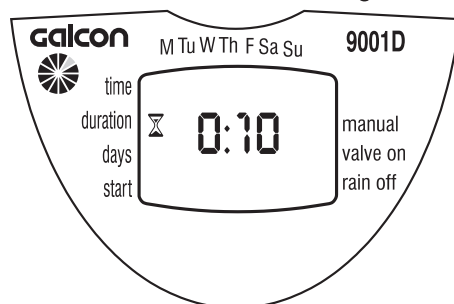



PROGRAMMING DURATION OF IRRIGATION

1. Press  until  appears opposite "Duration". The hour digits blink (0)
2. Press on  or  to change the watering duration in the example.
3. Press . The minute digits will blink. Press on  or  until the minute digits reach 10.



8

PROGRAMMING IRRIGATION DAYS

1. Press .  will appear opposite the word 'Days'. If you are programming the controller for the first time, the word OFF will blink on the display.
2. Press .  A blinking  will appear under Monday in the upper section of the display. Using , position the blinking marker under Tuesday, and press . The marker under Tuesday will stop blinking and another marker will start blinking under Wednesday. Press  twice more until the blinking marker reaches Friday. Press  again.

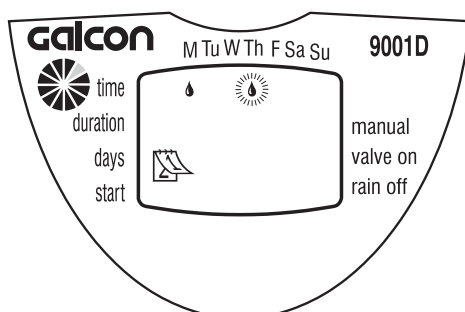

9

SETTING IRRIGATION START TIME/DATE

1. Press . STARTI will appear on the display. Press . The hour display will start blinking.
2. Using or set the start time at 08:00 AM (note the AM/PM indicators). Repeat this operation for the second irrigation period (START II) at 13:00, and for the third irrigation period (START III) at 19:00.
3. Press . START IV will appear on the display. Press . The hour digits will blink.
4. Press or until the word OFF appears on the display. The fourth irrigation start is canceled.

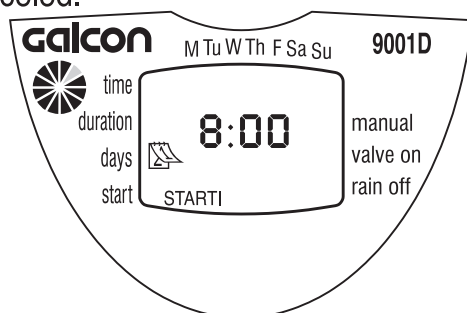

10

COMPUTERIZED MANUAL OPERATION

This option operates the valve for the defined irrigation period. The valve will close automatically at the end of the irrigation period.

Note that the originally programmed irrigation schedule will continue to function at the set times. This setting cannot be implemented when the display is blinking.

Operation: Press . will appear next to the word 'Manual', and will appear underneath it.

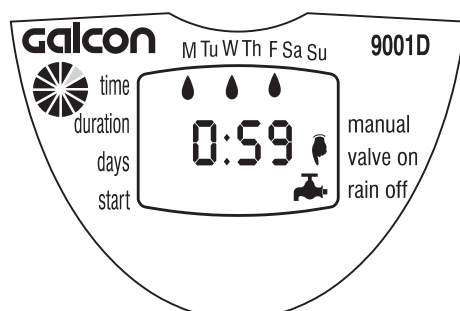



11

IRRIGATION CONTROLLER SUSPENSION

This option is used to temporarily suspend irrigation controller operation, for example, while it is raining. The irrigation operation schedule remains in the controller memory but is not implemented until the suspension is canceled.

Suspension: Press  for 3 consecutive seconds until the symbol  appears.

Cancel Suspension: Press  for 3 consecutive seconds to return irrigation system control to the irrigation controller. The  symbol will disappear. During suspension, the “Manual”  button will not function.

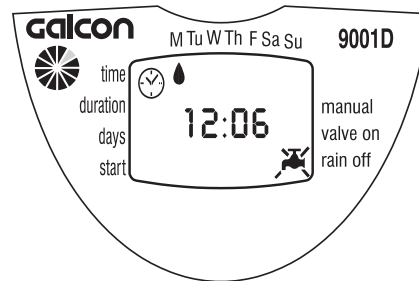

12

BLINKING LOW BATTERY WARNING

A blinking battery icon () appears on the display when the batteries are low. At this point, the battery still contains a limited amount of energy for valve operation. The battery should be replaced promptly.

If the battery is not replaced, the irrigation controller will continue to open the valve 8 times according to the program. It will then suspend the program and OFF will appear on the screen. Program data will be retained for 30 seconds while changing battery.

13

MISSING DEFINITION IN IRRIGATION PROGRAM

noPr will appear when programming irrigation days (see Programming a Weekly Irrigation Schedule), if no irrigation days have been specified. In this case, the valve cannot be opened during the computerized manual operation (see Computerized Manual Operation).



14

5 Maintenance

Remove batteries if the irrigation controller will not be used for a prolonged period. The controller contains an internal filter, which has to be removed and cleaned every few months. If the filter is not cleaned on a regular basis - it could create problems. The life span of the battery is at least one year.

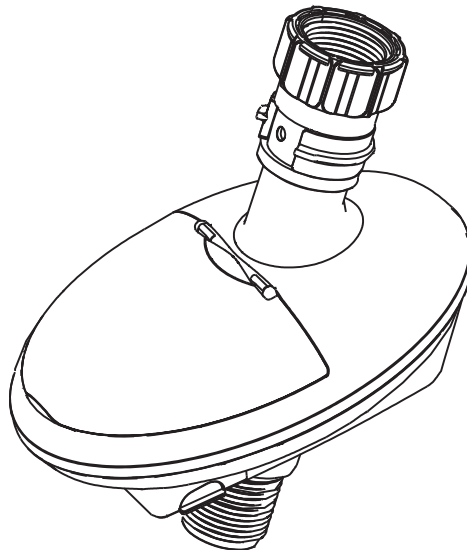

15